

論文 / 著書情報  
Article / Book Information

題目(和文)	Akbulut corkとAkbulut-Yasui plug上の種数0のLefschetz fibrationについて
Title(English)	Genus zero Lefschetz fibrations on the Akbulut cork and Akbulut-Yasui plugs
著者(和文)	浮田卓也
Author(English)	Takuya Ukida
出典(和文)	学位:博士(理学), 学位授与機関:東京工業大学, 報告番号:甲第10388号, 授与年月日:2017年3月26日, 学位の種別:課程博士, 審査員:遠藤 久顕,山田 光太郎,村山 光孝,服部 俊昭,KALMAN TAMAS
Citation(English)	Degree:Doctor (Science), Conferring organization: Tokyo Institute of Technology, Report number:甲第10388号, Conferred date:2017/3/26, Degree Type:Course doctor, Examiner:,,,,,
学位種別(和文)	博士論文
Type(English)	Doctoral Thesis

Genus zero Lefschetz fibrations on the Akbulut  
cork and Akbulut-Yasui plugs

Takuya Ukida

# Abstract

We first construct a genus zero positive allowable Lefschetz fibration over the disk (a genus zero PALF for short) on the Akbulut cork and describe the monodromy as a positive factorization in the mapping class group of a surface of genus zero with five boundary components. We then construct genus zero PALFs on infinitely many exotic pairs of compact Stein surfaces such that one is a cork twist of the other along an Akbulut cork. The difference of smooth structures on each of exotic pairs of compact Stein surface is interpreted as the difference of the corresponding positive factorizations in the mapping class group of a common surface of genus zero.

In the second part of this thesis, we construct a genus zero PALF on the Akbulut-Yasui plugs. We then construct genus zero PALFs on pairs of manifold such that one is a plug twist of the other along an Akbulut-Yasui plug.

Thanks to a result of Lisca and Matić and a refinement by Plamenevskaya, it is known that on a 4-manifold with boundary Stein structures with non-isomorphic  $\text{Spin}^c$  structures induce contact structures with distinct Ozsváth-Szabó invariants. In the third part of this thesis, we give an infinite family of examples showing that converse of Lisca-Matić-Plamenevskaya theorem does not hold in general. Our examples arise from Mazur type corks.

# Contents

<b>1</b>	<b>Introduction</b>	<b>1</b>
<b>2</b>	<b>A genus zero PALF on the Akbulut Cork</b>	<b>9</b>
2.1	Kirby diagrams . . . . .	9
2.2	Mapping class groups . . . . .	10
2.3	PALF . . . . .	10
2.4	Stein surfaces . . . . .	11
2.5	Corks . . . . .	12
2.6	Proofs of Theorems 1.0.1 and 1.0.2. . . . .	12
<b>3</b>	<b>Genus zero PALF on Akbulut-Yasui plugs</b>	<b>24</b>
3.1	Plugs . . . . .	24
3.2	Proofs of Theorems 1.0.3 and 1.0.4. . . . .	24
<b>4</b>	<b>Genus zero PALF and Stein structures with distinct Ozsváth-Szabó invariants on cork</b>	<b>34</b>
4.1	Proof of Theorem 1.0.6 . . . . .	34

# Chapter 1

## Introduction

Gompf [9] proved that compact Stein surfaces can be characterized in terms of handle decompositions, or more precisely, Kirby diagrams. Akbulut and Yasui [6] introduced corks and plugs, which are compact Stein surfaces themselves, and constructed various exotic smooth structures on Stein surfaces by using cork twists and plug twists together with Gompf's characterization and Seiberg-Witten invariants. On the other hand, Loi and Piergallini [15] proved that every compact Stein surface admits a positive allowable Lefschetz fibration over  $D^2$  (a PALF for short), which enables us to investigate compact Stein surfaces in terms of positive factorizations in mapping class groups (see also Akbulut and Ozbagci [5], Akbulut and ARIKAN [2]).

In this paper we first construct a genus zero PALF on the Akbulut cork and describe the monodromy as a positive factorization in the mapping class group of a fiber. The Akbulut cork is the pair  $(W_1, f_1)$  of the manifold  $W_1$  shown in Figure 1.1 and an involution  $f_1$  on  $W_1$  (see Definition 2.5.2). The manifold  $W_1$  is often called the Mazur manifold.

**Theorem 1.0.1.** *The manifold  $W_1$  admits a genus zero PALF. The monodromy of the PALF is described by the factorization  $t_{\alpha_4}t_{\alpha_3}t_{\alpha_2}t_{\alpha_1}$ , where  $t_\alpha$  is a right-handed Dehn twist along a simple closed curve  $\alpha$  on a fiber and  $\alpha_4, \dots, \alpha_1$  are simple closed curves shown in Figure 1.2.*

Note that the genus of a PALF on the manifold  $W_1$  which is obtained by

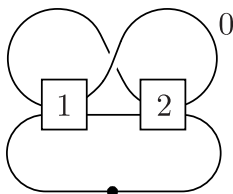

Figure 1.1: Kirby diagram for  $W_1$

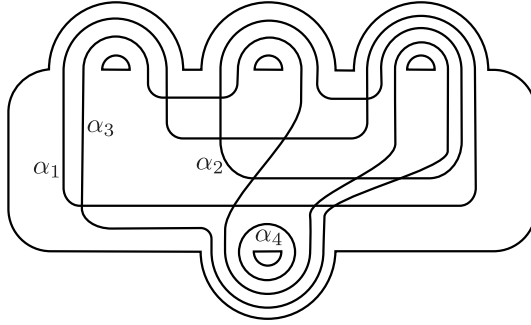

Figure 1.2: Vanishing cycles of a genus zero PALF on  $W_1$

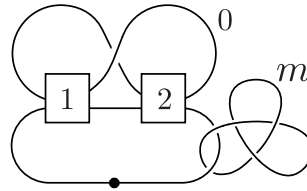

Figure 1.3: Kirby diagram for  $C_1(m, 1, 3, 0)$

applying any known method (cf. [5] and [2] ) is much larger than zero.

Akbulut and Yasui [7] proved that the compact Stein surfaces  $C_1(m, 1, 3, 0)$  and  $C_2(m, 1, 3, 0)$  ( $m \leq -5$ ) shown in Figure 1.3 and Figure 1.4 are homeomorphic but not diffeomorphic to each other. It is easily seen that  $C_2(m, 1, 3, 0)$  is a cork twist of  $C_1(m, 1, 3, 0)$  along an obvious Akbulut cork.

We next construct PALFs with the same fiber on  $C_1(m, 1, 3, 0)$  and  $C_2(m, 1, 3, 0)$  for each integer  $m$  less than  $-4$ . The common fiber is a surface of genus zero with  $-m + 5$  boundary components.

**Theorem 1.0.2.** *The manifolds  $C_1(m, 1, 3, 0)$  and  $C_2(m, 1, 3, 0)$  ( $m \leq -5$ ) shown in Figure 1.3 and Figure 1.4 admit genus zero PALFs. The monodromy of the PALF on  $C_1(m, 1, 3, 0)$  is described by the positive factorization*

$$t_{\delta_{-m+5}} \cdots t_{\delta_{11}} t_{\delta_{10}} t_{\delta_9} t_{\delta_8} t_{\delta_7} t_{\beta_6} t_{\beta_5} t_{\beta_4} t_{\beta_3} t_{\beta_2} t_{\beta_1}$$

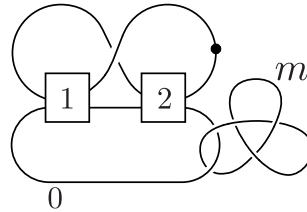

Figure 1.4: Kirby diagram for  $C_2(m, 1, 3, 0)$

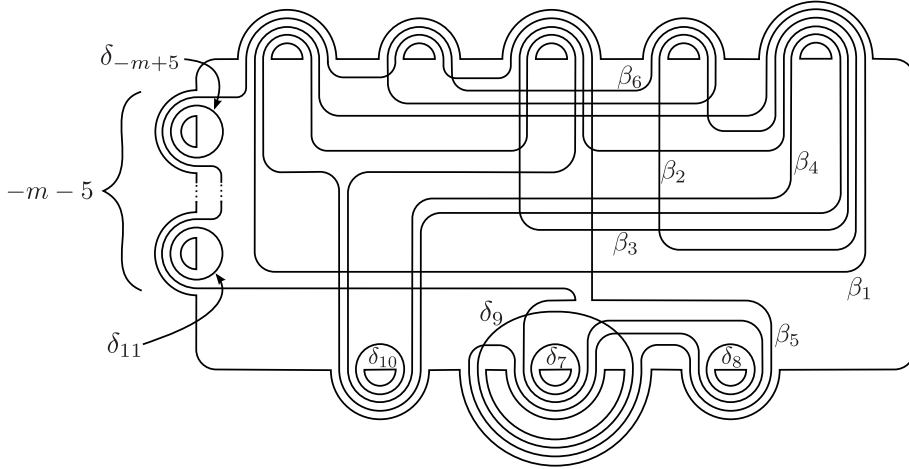

Figure 1.5: Vanishing cycles of a genus zero PALF on  $C_1(m, 1, 3, 0)$

while that for  $C_2(m, 1, 3, 0)$  is described by the positive factorization

$$t_{\delta_{-m+5}} \cdots t_{\delta_{11}} t_{\delta_{10}} t_{\delta_9} t_{\delta_8} t_{\delta_7} t_{\gamma_6} t_{\gamma_5} t_{\gamma_4} t_{\gamma_3} t_{\gamma_2} t_{\gamma_1}$$

, where  $\beta_i, \gamma_j$  are simple closed curves shown in Figure 1.5 and Figure 1.6.

The difference of smooth structures on  $C_1(m, 1, 3, 0)$  and  $C_2(m, 1, 3, 0)$  (or the effect of cork twisting the former to obtain the latter) is reflected in the corresponding positive factorizations as the difference between partial factorizations  $t_{\beta_6} t_{\beta_5} t_{\beta_4} t_{\beta_3} t_{\beta_2} t_{\beta_1}$  and  $t_{\gamma_6} t_{\gamma_5} t_{\gamma_4} t_{\gamma_3} t_{\gamma_2} t_{\gamma_1}$ .

In Chapter 2 we briefly review definitions of Mapping class groups, PALF, Stein surfaces, and corks, and recall several known results. We prove Theorem 1.0.1 and Theorem 1.0.2 in Section 2.6.

We next study PALF on Akbulut-Yasui plugs in Chapter 3. In Chapter 3, we construct a genus zero PALF structure on each of plugs introduced by Akbulut and Yasui [6] and describe the monodromy as a positive factorization in the mapping class group of a fiber.

**Theorem 1.0.3.** *For any  $m \geq 1, n \geq 2$ , Akbulut-Yasui plug  $(W_{m,n}, f_{m,n})$  admit genus zero PALF structure. The monodromy of the PALF is described by the factorization  $t_{\alpha_{2n+m}} \cdots t_{\alpha_1}$ , where  $t_\alpha$  is a right-handed Dehn twist along a simple closed curve  $\alpha$  on a fiber and  $\alpha_{2n+m}, \dots, \alpha_1$  are simple closed curves shown in Figure 1.8.*

In addition, we show that example of two 4-manifolds  $A$  and  $B$  which is obtained from  $A$  by plug twist of  $A$ . The manifolds  $A$  and  $B$  admit genus zero PALF structure, and have following properties:

**Theorem 1.0.4.** *The manifolds  $A$  and  $B$  which are showed by the Kirby diagrams in the Figure 1.9 have following properties.*

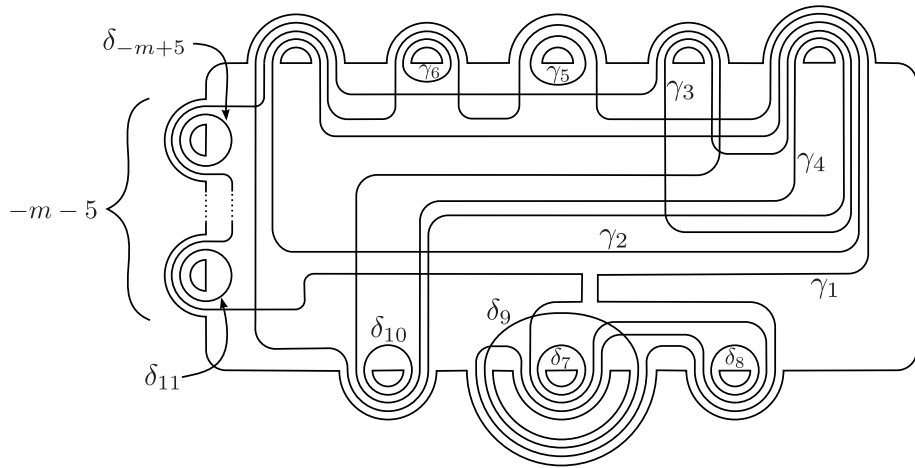

Figure 1.6: Vanishing cycles of a genus zero PALF on  $C_2(m, 1, 3, 0)$

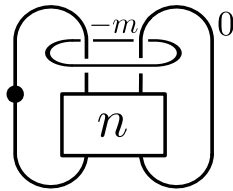

Figure 1.7: Kirby diagram for  $W_{m,n}$

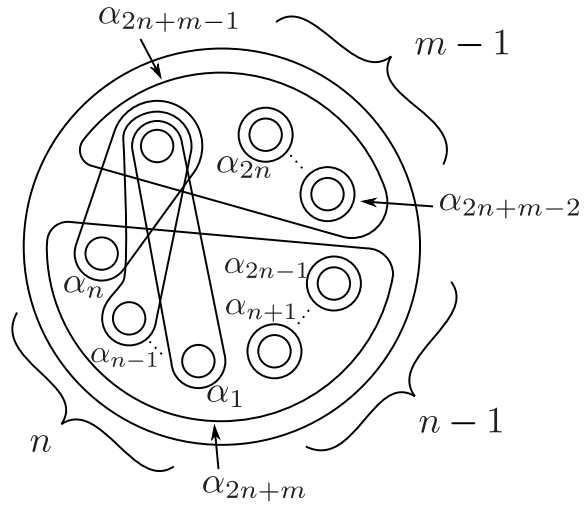

Figure 1.8: Vanishing cycles of a genus zero PALF on  $W_{m,n}$ .

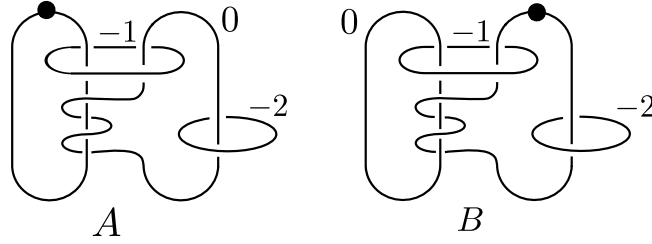

Figure 1.9: Kirby diagrams for  $A$  and  $B$ .

- (1)  $B$  is obtained by plug twist of  $A$  along Akbulut-Yasui plug  $(W_{1,2}, f_{1,2})$ .
- (2)  $A, B$  admit genus zero PALF structure.
- (3) Betti numbers of  $A$  and  $B$  are 2, and Homology groups of  $A$  and  $B$  are isomorphic.
- (4) The boundaries of  $A$  and  $B$  are diffeomorphic.
- (5)  $A, B$  do not have isomorphic intersection numbers. Especially  $A$  and  $B$  are not homeomorphic.
- (6) The monodromy representation of genus zero PALF structures which  $W_{1,2}$  admits is  $t_{\alpha_4} t_{\alpha_3} t_{\alpha_2} t_{\alpha_1}$ , where  $\alpha_i$  is a simple closed curve in diagram 1.10, and  $t_{\alpha_i}$  is right-handed Dehn twist along  $\alpha_i$ . Monodromy representations of genus zero PALF structure of  $A, B$  are  $t_{\alpha_4} t_{\alpha_3} t_{\alpha_2} t_{\alpha_1} t_{\beta}$  and  $t_{\alpha_4} t_{\alpha_3} t_{\alpha_2} t_{\alpha_1} t_{\gamma}$ , where  $\beta, \gamma$  is simple closed curve in the diagram 1.11, 1.12.

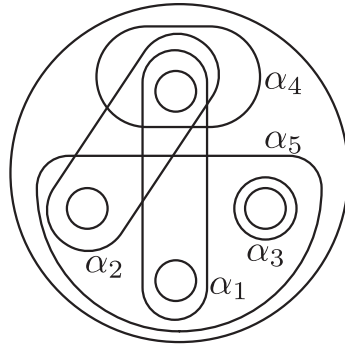

Figure 1.10: Vanishing cycles of a genus zero PALF on  $W_{1,2}$ .

The results in Chapter 4 of the thesis are based on joint work with Çağrı Karakurt and Takahiro Oba.

For any contact structure  $\xi$  on a 3-manifold  $Y$ , let  $c^+(\xi) \in HF^+(-Y)$  denote its Ozsváth-Szabó invariant. Recall Lisca-Matić-Plamenevskaya theorem:

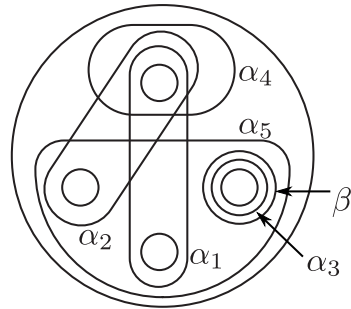

Figure 1.11: Vanishing cycles of a genus zero PALF.

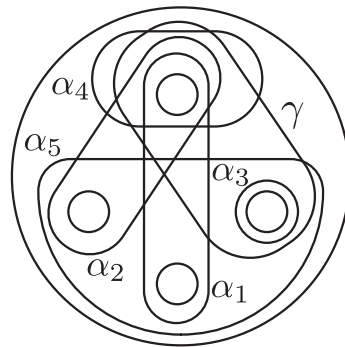

Figure 1.12: Vanishing cycles of a genus one PALF.

**Theorem 1.0.5.** [14, Theorem 1.2] [19, Theorem 2] *Let  $W$  be a smooth compact 4-manifold with boundary  $W$  equipped with two Stein structures  $J_1$  and  $J_2$  with associated  $\text{Spin}^c$  structures  $\mathfrak{s}_1$  and  $\mathfrak{s}_2$  on  $W$ , and the induced contact structures  $\xi_1$  and  $\xi_2$  on  $\partial W$ . If  $\mathfrak{s}_1$  and  $\mathfrak{s}_2$  are not isomorphic then  $\xi_1$  and  $\xi_2$  are not isotopic; In fact  $c^+(\xi_1) \neq c^+(\xi_2)$*

In the light of the above theorem a natural question to ask is whether the  $\text{Spin}^c$  structure of a Stein filling completely determines the Ozsváth-Szabó invariant of the induced contact structure. An evidence towards a positive answer was provided in a work of Karakurt [12, Proposition 1.2] where it was shown that the Ozsváth-Szabó invariant depends only on the first Chern class of the Stein filling on  $W$  when the total space of the filling is a special type of plumbing. Our main result suggests that the answer is in general negative. To state it let  $\pi : HF^+(-\partial Y) \rightarrow HF_{red}(-\partial Y)$  be the natural projection map from the plus flavor to reduced Heegaard Floer homology.

**Theorem 1.0.6.** *There exists an infinite family  $\{W^n : n \in \mathbb{N}\}$  of compact contractible 4-manifolds with boundary and Stein structures  $J_1^n$  and  $J_2^n$  on  $W^n$  satisfying the following properties:*

1. *The  $\text{Spin}^c$  structures  $\mathfrak{s}_1^n$  and  $\mathfrak{s}_2^n$  associated to  $J_1^n$  and  $J_2^n$ , respectively, are the same for every  $n \in \mathbb{N}$ .*
2. *The induced contact structures  $\xi_1^n$  and  $\xi_2^n$  on  $\partial W^n$  have distinct Ozsváth-Szabó invariants, in fact  $\pi(c^+(\xi_1^n)) \neq 0$  and  $\pi(c^+(\xi_2^n)) = 0$ , for every  $n \in \mathbb{N}$ .*
3. *the Casson invariant of  $\partial W^n$  is given by  $\lambda(\partial W^n) = 2n$  for every  $n \in \mathbb{N}$ .*
4.  *$\partial W^n$  is irreducible for every  $n \in \mathbb{N}$ .*

Our examples  $W^n$  are Mazur type manifolds obtained from the symmetric link  $L^n$  in Figure 1.13 by putting a dot on one of the components and attaching a 0-framed 2-handle to the other component as in Figure 1.14. Note that the manifold  $W^1$  is the Akbulut cork. A Stein structure  $J_1^n$  on  $W^n$  can immediately be obtained by drawing a Legendrian representative of the attaching circle of the 2-handle and stabilizing as necessary to make the framing one less than the Thurston-Bennequin framing. Even though the choice of stabilizations is not unique, and different stabilizations potentially yield Stein structures with distinct Ozsváth-Szabó invariants, the direct computation of these invariants does not seem plausible. Hence we take a different approach and construct the second Stein structure  $J_2^n$  using the Loi-Piergallini-Akbulut-Ozbagci correspondence between Stein structures and positive allowable Lefschetz fibrations (PALFs in short). Our key observation is that  $W^n$  admits a planar PALF, that is, a PALF with planar fiber. This was already shown for the Akbulut cork  $W^1$  by author [20]. The main result for  $W^1$  then immediately follows by bringing together some known facts in the literature (see our proof below). One can easily promote author's example to an infinite family by repeatedly taking boundary

sums of  $W^1$ . The irreducibility of  $\partial W^n$  shows that our examples do not arise in this manner. In the body of our work we generalize author's planar PALF construction to  $W^n$ , and compute the Casson invariants to distinguish  $\partial W^n$ 's. Along the way we also prove that  $\partial W^n$  is obtained from  $S^3$  by  $1/n$ -surgery on a knot, a fact we find interesting in its own right.

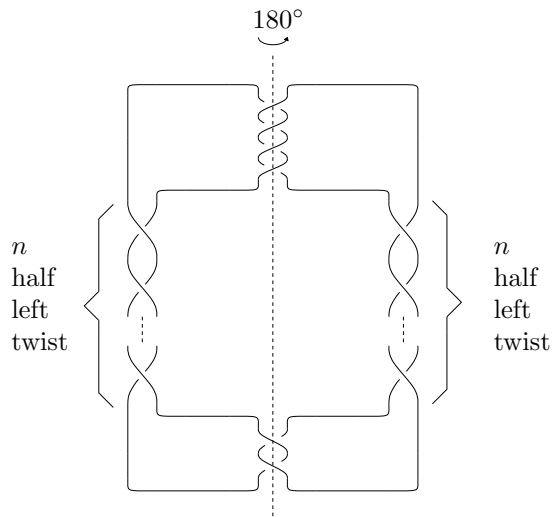

Figure 1.13: Symmetric picture of  $L^n$ . The indicated involution exchanges the components.

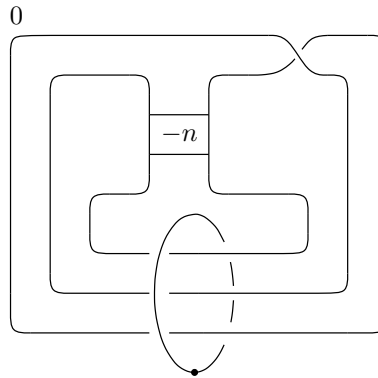

Figure 1.14: The handlebody  $W^n = W(L^n)$ . The box indicates  $n$  full left twists.

**Acknowledgements.** The author would like to thank his adviser Hisaaki Endo for his helpful comments and his encouragement. The author wishes to thank Kouichi Yasui for his useful comments.

## Chapter 2

# A genus zero PALF on the Akbulut Cork

In this chapter, we recall a definitions of Kirby diagrams, Mapping class groups, PALF, and Stein surfaces. We next prove Theorem 1.0.1 and 1.0.2.

The results in Chapter 2 of the thesis are based on [20].

### 2.1 Kirby diagrams

In this section we review the definitions of Kirby diagrams (for details, see [10]).

**Definition 2.1.1.** For  $0 \leq k \leq n$ , an  $n$ -dimensional  $k$ -handle  $h$  is a copy of  $D^k \times D^{n-k}$ , attached to the boundary of an  $n$ -manifold  $X$  along  $\partial D^k \times D^{n-k}$  by an embedding  $\varphi : \partial D^k \times D^{n-k} \rightarrow \partial X$ . We will call  $\varphi$  the *attaching map*,  $\partial D^k \times 0$  the *attaching sphere*,  $\partial D^k \times D^{n-k}$  the *attaching region* and  $0 \times \partial D^{n-k}$  the *belt sphere*.

**Definition 2.1.2.** Let  $X$  be a compact  $n$ -manifold with boundary  $\partial X$  decomposed as a disjoint union  $\partial_+ X \amalg \partial_- X$  of two compact submanifolds (either of which may be empty). If  $X$  is oriented, orient  $\partial_\pm X$  so that  $\partial X = \partial_+ X \amalg \partial_- X$  in the boundary orientation. A *handle decomposition* of  $X$  (relative to  $\partial_- X$ ) is an identification of  $X$  with a manifold obtained from  $I \times \partial_- X$  by attaching handles, such that  $\partial_- X$  corresponds to  $0 \times \partial_- X$  in the obvious way. A manifold  $X$  with a given handle decomposition is called a *relative handlebody* built on  $\partial_- X$ , or if  $\partial_- X = \emptyset$  it is called a *handlebody*.

Every smooth, compact manifold pair  $(X, \partial_- X)$  admits a handle decomposition by Morse Theory.

**Fact 2.1.3.** *Any handle decomposition of a compact pair  $(X, \partial_- X)$  can be modified (by isotoping attaching maps) so that the handles are attached in order of increasing index. Handles of the same index can be attached in any order (or simultaneously).*

**Fact 2.1.4.** *A  $(k - 1)$ -handle  $h_{k-1}$  and a  $k$ -handle  $h_k$  ( $1 \leq k \leq n$ ) can be cancelled, provided that the attaching sphere of  $h_k$  intersects the belt sphere of  $h_{k-1}$  transversely in a single point.*

**Definition 2.1.5.** Given two  $k$ -handles  $h_1$  and  $h_2$  ( $0 < k < n$ ) attached to  $\partial X$ , a *handle slide* of  $h_1$  over  $h_2$  is given by the following procedure. Isotopo the attaching sphere  $A$  of  $h_1$  in  $\partial(X \cup h_2)$ , pushing it through the belt sphere  $B$  of  $h_2$ . At the intermediate stage, the spheres will intersect in one point  $p$  (with  $T_p A \oplus T_p B$  of codimension 1 in  $T_p \partial(X \cup h_2)$ ). We will have a choice of directions for pushing  $A$  off of  $B$ . One direction gives the original picture, and the other gives the result of the handle slide.

**Theorem 2.1.6.** [14] *Given any two relative handle decompositions (ordered by increasing index) for a compact pair  $(X, \partial_- X)$ , it is possible to get from one to the other by a sequence of handle slides, creating/annihilating cancelling handle pairs and isotopies within levels.*

**Definition 2.1.7.** A *Kirby diagram* is a description of a 4-dimensional (relative) handlebody by a diagram in  $\mathbb{R}^3$ .

In the Kirby diagram, the attaching region  $S^0 \times D^3$  of 1-handle is represented by the pair of round balls. The 2-handle is represented by a knot with framing.

## 2.2 Mapping class groups

In this section we review a precise definition of mapping class groups of surfaces with boundary and that of Dehn twists along simple closed curves on surfaces.

**Definition 2.2.1.** Let  $F$  be a compact oriented connected surface with boundary. Let  $\text{Diff}^+(F, \partial F)$  be the group of all orientation-preserving self-diffeomorphisms of  $F$  fixing the boundary  $\partial F$  point-wise. Let  $\text{Diff}_0^+(F, \partial F)$  be the subgroup of  $\text{Diff}^+(F, \partial F)$  consisting of self-diffeomorphisms isotopic to the identity. The quotient group  $\text{Diff}^+(F, \partial F) / \text{Diff}_0^+(F, \partial F)$  is called the mapping class group of  $F$  and it is denoted by  $\text{Map}(F, \partial F)$ .

**Definition 2.2.2.** A *positive (or right-handed) Dehn twist* along a simple closed curve  $\alpha$ ,  $t_\alpha : F \rightarrow F$  is a diffeomorphism obtained by cutting  $F$  along  $\alpha$ , twisting  $360^\circ$  to the right and regluing.

## 2.3 PALF

**Definition 2.3.1.** Let  $M^4$  and  $B^2$  be compact oriented smooth manifolds of dimensions 4 and 2. Let  $f : M \rightarrow B$  be a smooth map.  $f$  is called a *positive Lefschetz fibration* over  $B$  if it satisfies the following conditions (1) and (2):

- (1) There are finitely many critical values  $b_1, \dots, b_m$  of  $f$  in the interior of  $B$  and there is a unique critical point  $p_i$  on each fiber  $f^{-1}(b_i)$ , and

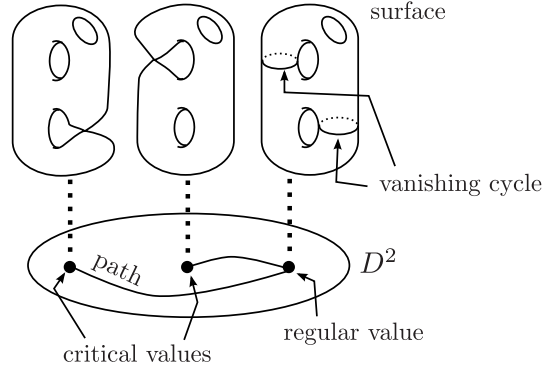

Figure 2.1: PALF

- (2) The map  $f$  is locally written as  $f(z_1, z_2) = z_1^2 + z_2^2$  with respect to some local complex coordinates around  $p_i$  and  $b_i$  compatible with the orientations of  $M$  and  $B$ .

**Definition 2.3.2.** A positive Lefschetz fibration is called *allowable* if its all vanishing cycles are homologically non-trivial on the fiber. A positive allowable Lefschetz fibration over  $D^2$  with bounded fibers is called a *PALF* for short.

The following Lemma is useful to prove Theorem 1.0.1.

**Lemma 2.3.3** (cf. Akbulut-Ozbagci [5, Remark 1]). *Suppose that a 4-manifold  $X$  admits a PALF. If a 4-manifold  $Y$  is obtained from  $X$  by attaching a Lefschetz 2-handle, then  $Y$  also admits a PALF.*

The Lefschetz 2-handle is defined as follows.

**Definition 2.3.4.** Suppose that  $X$  admits a PALF. A *Lefschetz 2-handle* is a 2-handle attached along a homologically non-trivial simple closed curve in the boundary of  $X$  with framing  $-1$  relative to the product framing induced by the fiber structure.

## 2.4 Stein surfaces

In this section, we recall a definition of Stein surfaces. The question of which smooth 4-manifolds admit Stein structures can be completely reduced to a problem in handlebody theory.

**Definition 2.4.1.** A complex manifold is called a *Stein manifold* if it admits a proper biholomorphic embedding to  $\mathbb{C}^n$ .

**Definition 2.4.2.** Let  $W$  be a compact manifold with boundary. The manifold  $W$  is called a *Stein domain* if it satisfies following condition: There is a Stein manifold  $X$  and a plurisubharmonic function  $\varphi : X \rightarrow [0, \infty)$  such that  $W = \varphi^{-1}([0, a])$  for a regular value  $a$  of  $\varphi$ .

**Definition 2.4.3.** A Stein manifold or a Stein domain is called a *Stein surface* if its complex dimension is 2.

## 2.5 Corks

Corks are Stein surfaces and they are useful for constructing exotic manifolds.

**Definition 2.5.1.** Let  $C$  be a Stein domain. Let  $\tau : \partial C \rightarrow \partial C$  be an involution on the boundary  $\partial C$  of  $C$ .

- (1)  $(C, \tau)$  is called a *cork* if  $\tau$  extends to a self-homeomorphism of  $C$ , but does not extend to any self-diffeomorphism of  $C$ .
- (2) Suppose that  $C$  is embedded in a smooth 4-manifold  $X$ . The manifold obtained from  $X$  by removing  $C$  and regluing it via  $\tau$  is called a *cork twist* of  $X$  along  $(C, \tau)$ .
- (3) The pair  $(C, \tau)$  is called a *cork of  $X$*  if the cork twist of  $X$  along  $(C, \tau)$  is homeomorphic but not diffeomorphic to  $X$ .

In this paper, we investigate Akbulut cork  $(W_1, f_1)$  ([Ak]).

**Definition 2.5.2.** Let  $W_1$  be a smooth 4-manifold given by Figure 1.1. Let  $f_1 : \partial W_1 \rightarrow \partial W_1$  be the obvious involution obtained by first surgering  $S^1 \times D^3$  to  $D^2 \times S^2$  in the interiors of  $W_1$ , then surgering the other imbedded  $D^2 \times S^2$  back to  $S^1 \times D^2$ .

**Theorem 2.5.3** (Akbulut [1]). *The pair  $(W_1, f_1)$  is a cork.*

Akbulut and Yasui constructed infinitely many exotic pairs.

**Theorem 2.5.4** (Akbulut-Yasui [7, Theorem 3.3(2)]).  *$C_1(m, n, p, 0)$  and  $C_2(m, n, p, 0)$  are homeomorphic but not diffeomorphic to each other, for  $1 \leq n \leq 3, p \geq 3$  and  $m \leq p^2 - 3p + 1$ .*

## 2.6 Proofs of Theorems 1.0.1 and 1.0.2.

We write Theorem 1.0.1 once again here.

**Theorem 1.0.1.** *The manifold  $W_1$  admits a genus zero PALF. The monodromy of the PALF is described by the factorization  $t_{\alpha_4} t_{\alpha_3} t_{\alpha_2} t_{\alpha_1}$ , where  $t_\alpha$  is a right-handed Dehn twist along a simple closed curve  $\alpha$  on a fiber and  $\alpha_4, \dots, \alpha_1$  are simple closed curves shown in Figure 2.5.*

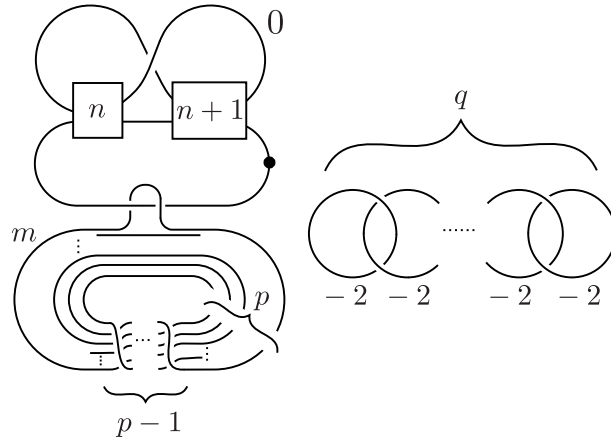
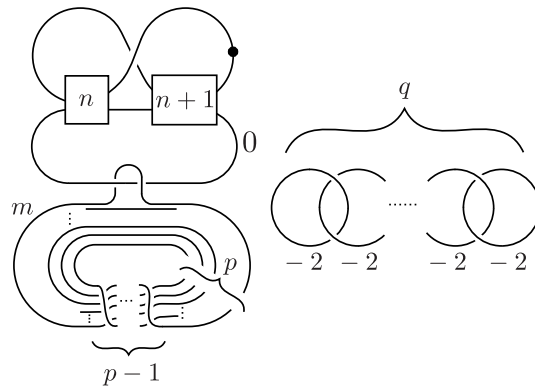
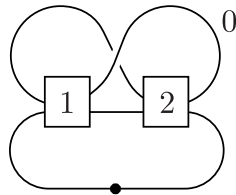
Figure 2.2: Kirby diagram for  $C_1(m, n, p, q)$ Figure 2.3: Kirby diagram for  $C_2(m, n, p, q)$ Figure 2.4: Kirby diagram for  $W_1$

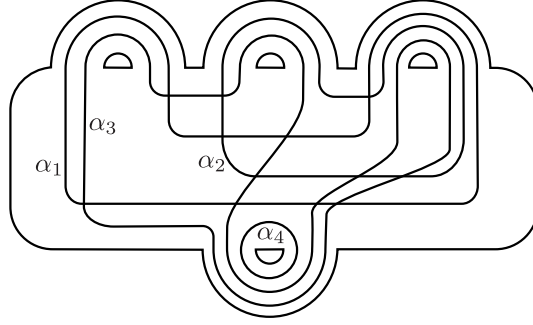
Figure 2.5: Vanishing cycles of a genus zero PALF on  $W_1$ 

*Proof of Theorem 1.0.1.* Let  $F$  be the compact oriented surface of genus zero with 5 boundary components and  $\alpha_1, \dots, \alpha_4$  be the curves on  $F$  shown in Figure 2.5. We denote the right-handed Dehn twists along  $\alpha_1, \dots, \alpha_4$  by  $t_{\alpha_1}, \dots, t_{\alpha_4}$ , respectively. Let  $f : X \rightarrow D^2$  be a Lefschetz fibration over  $D^2$  with monodromy representation  $(t_{\alpha_4}, \dots, t_{\alpha_1})$ . Since each curve  $\alpha_i$  is homologically non-trivial on  $F$ , we see that  $f$  is a PALF with fiber  $F$ .

We now show that  $X$  is diffeomorphic to  $W_1$ . The obvious Kirby diagram for  $W_1$  is given by Figure 2.4. We draw it as in Figure 2.6(a), and create the cancelling pair to get Figure 2.6(b). We slide the 0-framed 2-handle over the 1-framed 2-handle to get Figure 2.6(c). We get Figure 2.6(d) by sliding the  $-3$ -framed 2-handle over the 1-framed 2-handle. By 1-handle slide, we get Figure 2.6(e). We slide the  $-4$ -framed 2-handle over the 1-framed 2-handle, and erase a cancelling 1-handle/2-handle pair to get Figure 2.6(f). We create the cancelling pairs to get Figure 2.6(g). We get Figure 2.6(h) by creating the cancelling pairs.

The Kirby diagram for  $X$  corresponding to the monodromy representation  $t_{\alpha_4}, \dots, t_{\alpha_1}$  is given by Figure 2.6(h).

Therefore we conclude that  $X$  is diffeomorphic to  $W_1$ , which implies the theorem.  $\square$

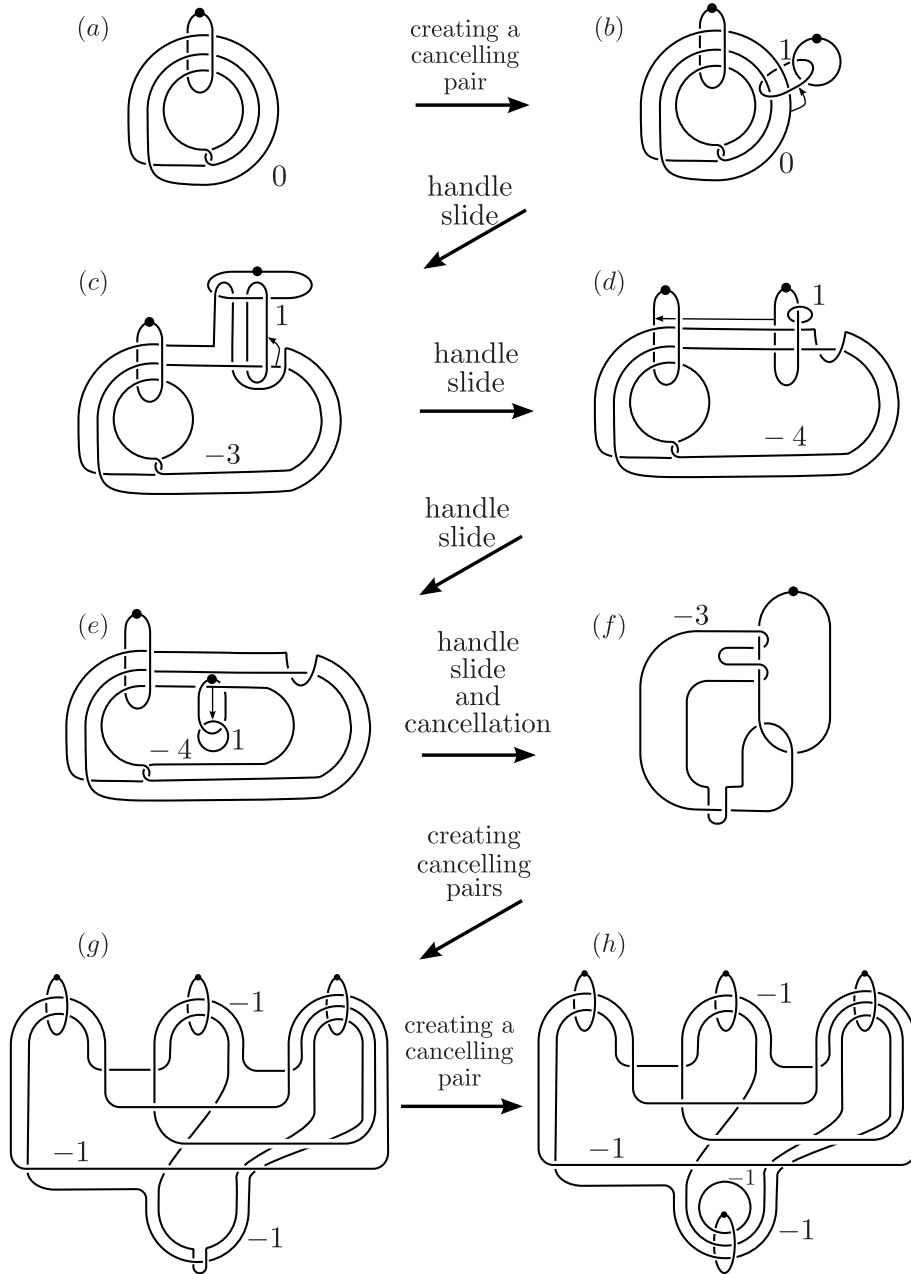
Figure 2.6: Kirby calculus for  $W_1$

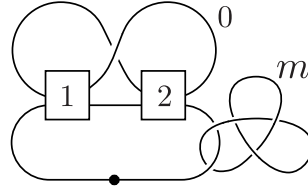
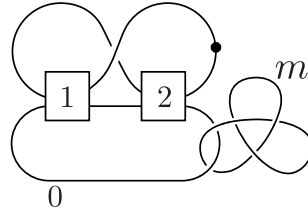
Figure 2.7: Kirby diagram for  $C_1(m, 1, 3, 0)$ Figure 2.8: Kirby diagram for  $C_2(m, 1, 3, 0)$ 

We write Theorem 1.0.2 once again here.

**Theorem 1.0.2.** *The manifolds  $C_1(m, 1, 3, 0)$  and  $C_2(m, 1, 3, 0)$  ( $m \leq -5$ ) shown in Figure 2.7 and Figure 2.8 admit genus zero PALFs. The monodromy of the PALF on  $C_1(m, 1, 3, 0)$  is described by the positive factorization*

$$t_{\delta_{-m+5}} \cdots t_{\delta_{11}} t_{\delta_{10}} t_{\delta_9} t_{\delta_8} t_{\delta_7} t_{\beta_6} t_{\beta_5} t_{\beta_4} t_{\beta_3} t_{\beta_2} t_{\beta_1}$$

while that for  $C_2(m, 1, 3, 0)$  is described by the positive factorization

$$t_{\delta_{-m+5}} \cdots t_{\delta_{11}} t_{\delta_{10}} t_{\delta_9} t_{\delta_8} t_{\delta_7} t_{\gamma_6} t_{\gamma_5} t_{\gamma_4} t_{\gamma_3} t_{\gamma_2} t_{\gamma_1}$$

, where  $\beta_i, \gamma_j$  are simple closed curves shown in Figure 2.9 and Figure 2.10.

*Proof of Theorem 1.0.2.* Let  $F_{C_i(m,1,3,0)}$  ( $i = 1, 2$ ) be the compact oriented surface of genus zero with  $-m + 5$  boundary components and  $\beta_1, \dots, \beta_{-m+5}$  and  $\gamma_1, \dots, \gamma_{-m+5}$  be the curves on  $F_{C_i(m,1,3,0)}$  shown in Figure 2.9 and Figure 2.10, respectively. Let  $g_1 : X_{C_1(m,1,3,0)} \rightarrow D^2$  (resp.  $g_2 : X_{C_2(m,1,3,0)} \rightarrow D^2$ ) be a Lefschetz fibration over  $D^2$  with monodromy representation  $(t_{\beta_{-m+5}}, \dots, t_{\beta_1})$  (resp.  $(t_{\gamma_{-m+5}}, \dots, t_{\gamma_1})$ ). Since each curve  $\beta_i$  (resp.  $\gamma_i$ ) is homologically non-trivial on  $F_{C_1(m,1,3,0)}$  (resp.  $F_{C_2(m,1,3,0)}$ ), we see that  $g_1$  (resp.  $g_2$ ) is a PALF with fiber  $F_{C_1(m,1,3,0)}$  (resp.  $F_{C_2(m,1,3,0)}$ ).

The Kirby diagram for  $C_1(m, 1, 3, 0)$  is given by Figure 2.7. We get Figure 2.11(a) by isotopy. We create a cancelling pair to get Figure 2.11(b). We slide the 0-framed 2-handle over the 1-framed 2-handle to get Figure 2.11(c). By sliding the  $-3$ -framed 2-handle over the 1-framed 2-handle, we get Figure 2.11(d). We get Figure 2.11(e) by 1-handle slide. We obtain Figure 2.11(f) by handle slides and cancellation. By handle slide and creating a cancelling pair, we get Figure 2.12(g). We get Figure 2.12(h) by handle slide and creating a cancelling pair.

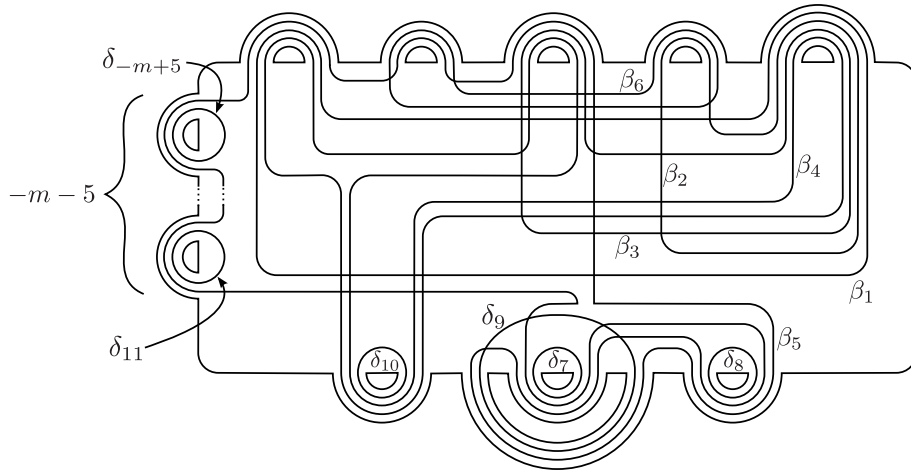
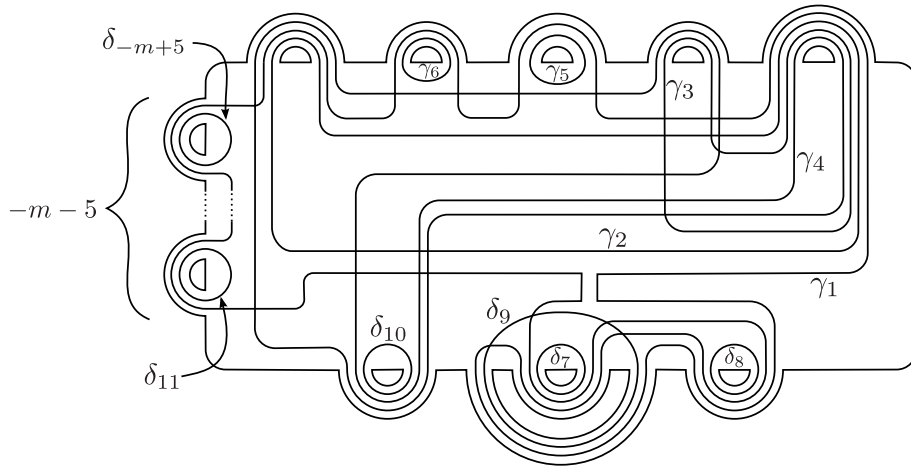
Figure 2.9: Vanishing cycles of a genus zero PALF on  $C_1(m, 1, 3, 0)$ Figure 2.10: Vanishing cycles of a genus zero PALF on  $C_2(m, 1, 3, 0)$

We slide the  $m$ -framed 2-handle over a  $-1$ -framed 2-handle to get Figure ??(i). In Figure 2.12(i), creating a cancelling pair gives Figure 2.12(j). We create cancelling pairs to get Figure 2.13(k).

The Kirby diagram for  $X_{C_1(m,1,3,0)}$  corresponding to the monodromy representation  $t_{\beta_{-m+5}}, \dots, t_{\beta_1}$  is given by 2.13(k).

The Kirby diagram for  $C_2(m,1,3,0)$  is given by Figure 2.8. We get Figure 2.14(a) by isotopy. We obtain Figure 2.14(b) by handle slides and cancellation (see the proof of Theorem 1.0.1). By creating cancelling pairs, we get Figure 2.14(c). We slide the  $m$ -framed 2-handle under a 1-handle to get Figure 2.14(d). In Figure 2.14(d), handle slides gives Figure 2.14(e). We create cancelling pairs to get Figure 2.15(f).

The Kirby diagram for  $X_{C_2(m,1,3,0)}$  corresponding to the monodromy representation  $t_{\gamma_{-m+5}}, \dots, t_{\gamma_1}$  is given by Figure 2.15(f).

Therefore we conclude that the manifolds  $C_1(m,1,3,0)$  and  $C_2(m,1,3,0)$  admit genus zero PALFs.  $\square$

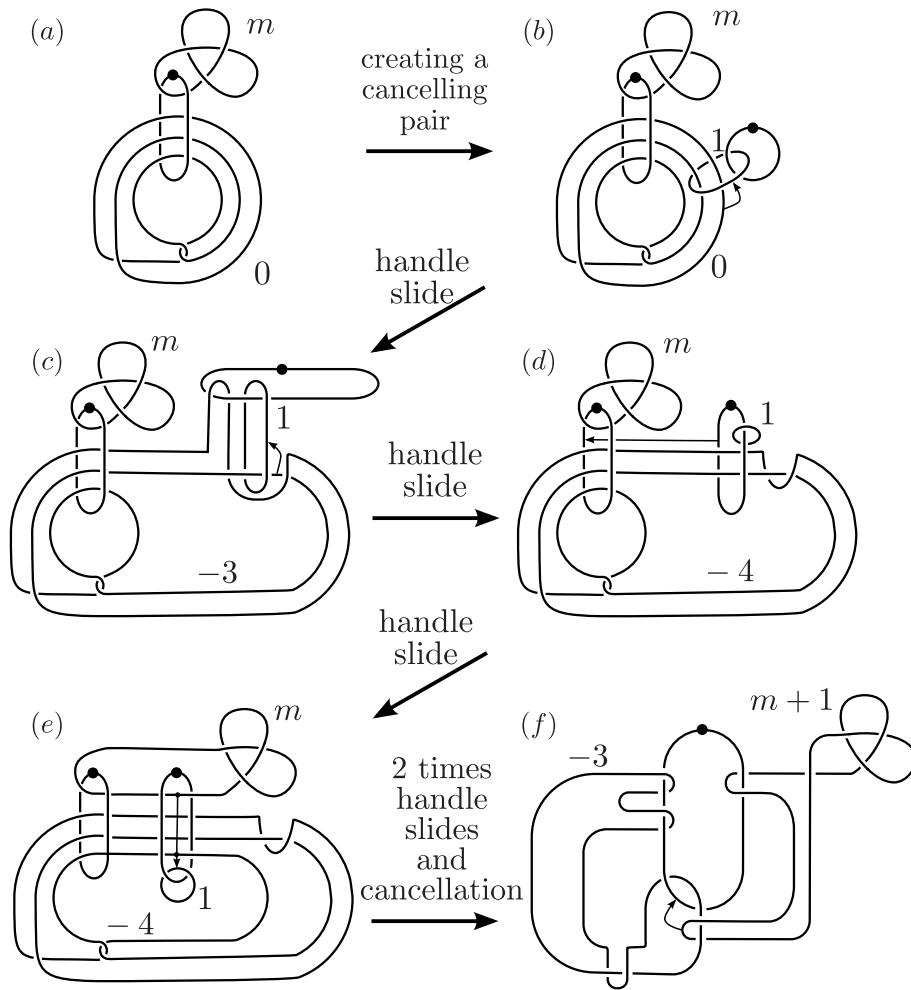
Figure 2.11: Kirby calculus for  $C_1(m, 1, 3, 0)$

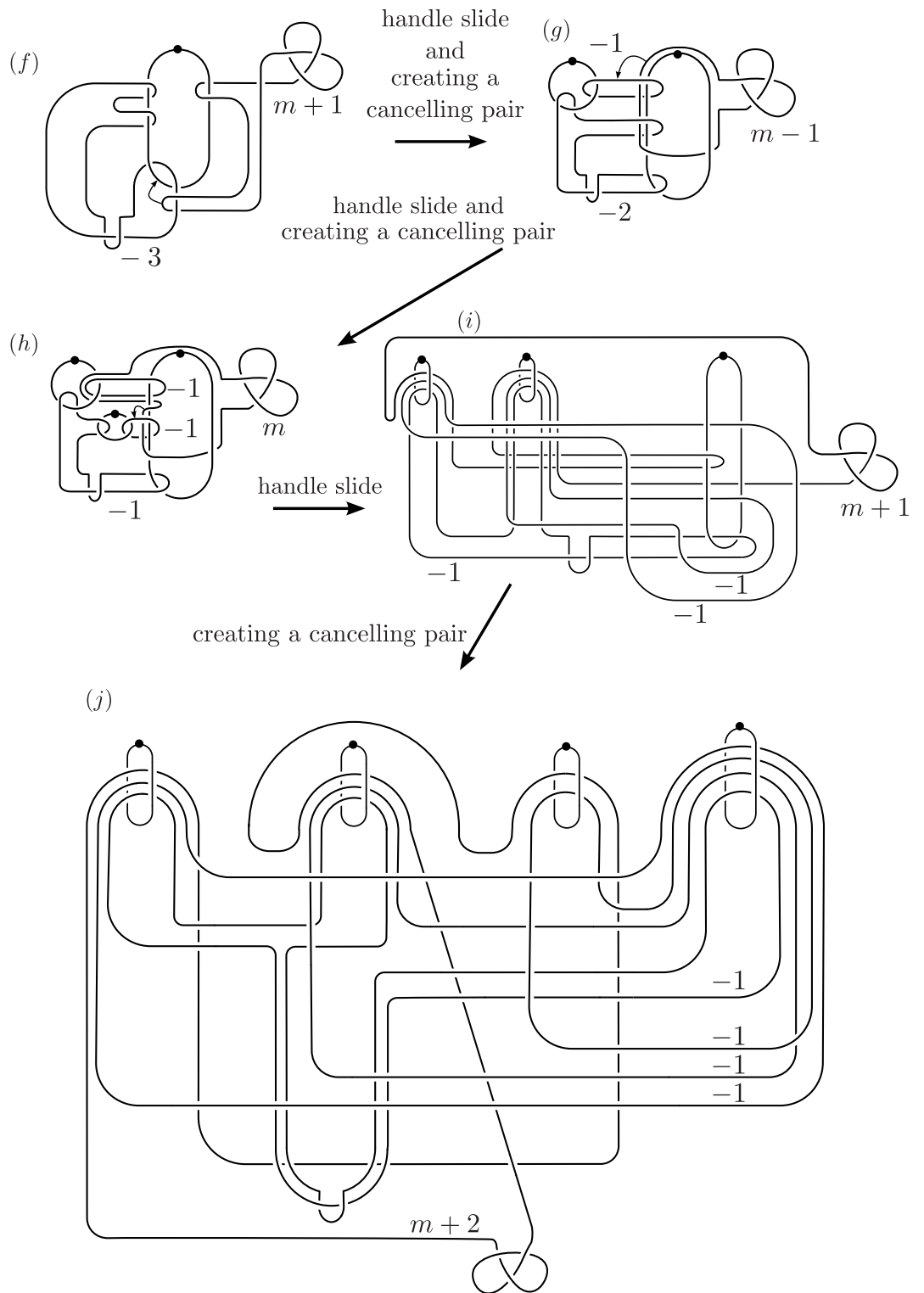

Figure 2.12: Kirby calculus for  $C_1(m, 1, 3, 0)$



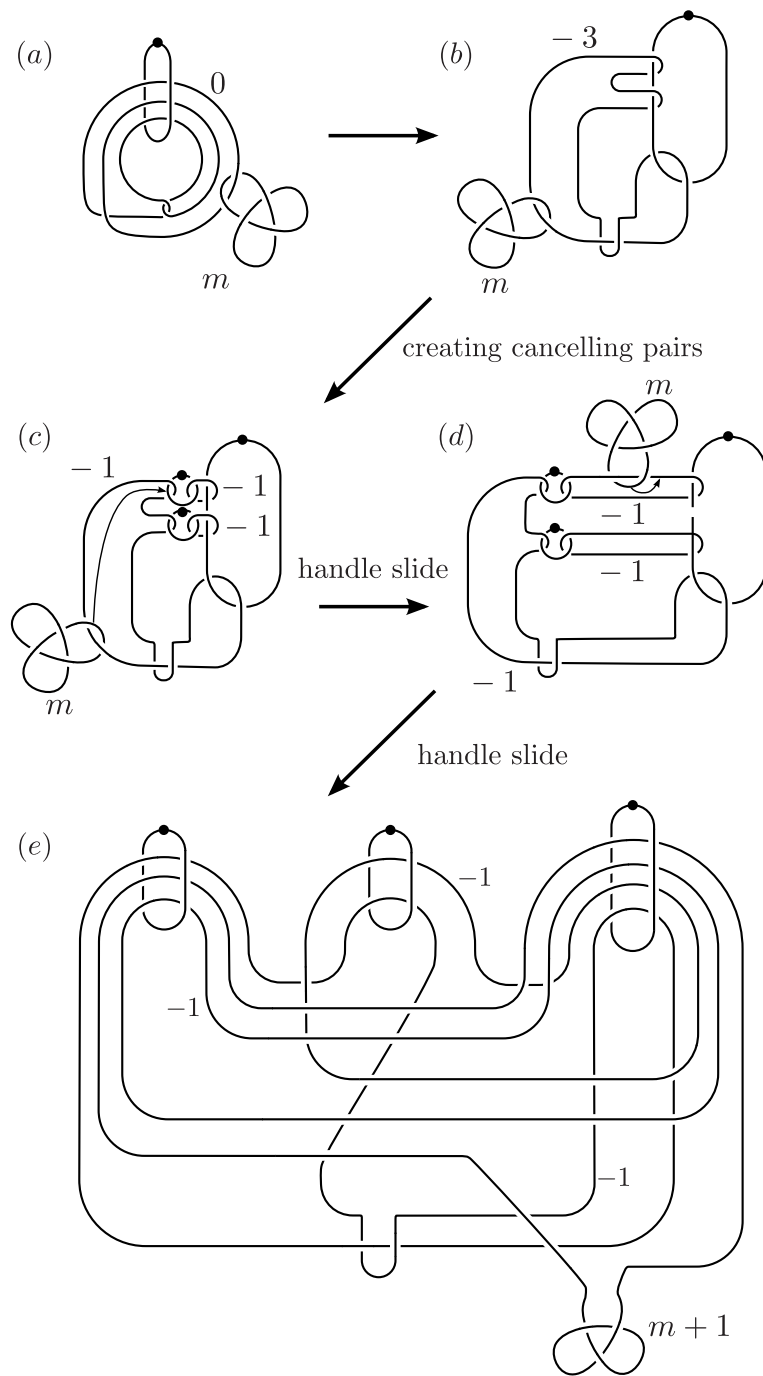

Figure 2.14: Kirby calculus for  $C_2(m, 1, 3, 0)$

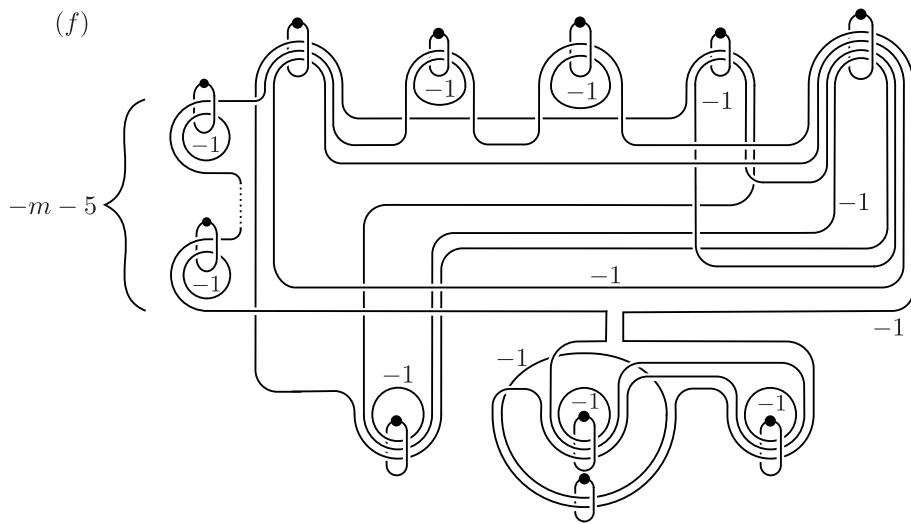

Figure 2.15: The manifold  $C_2(m, 1, 3, 0)$  admits genus zero PALF

## Chapter 3

# Genus zero PALF on Akbulut-Yasui plugs

In this chapter, we give the definition of plug and prove Theorem 1.0.3 and Theorem 1.0.4.

### 3.1 Plugs

**Definition 3.1.1.** (Akbulut-Yasui [6, Definition 2.3.]) Let  $W_{m,n}$  be a smooth 4-manifold given by Figure 3.1. Let  $f_{m,n} : \partial W_{m,n} \rightarrow \partial W_{m,n}$  be the obvious involution obtained from first surgering  $S^1 \times D^3$  to  $D^2 \times S^2$  in the interiors of  $W_{m,n}$ , then surgering the other imbedded  $D^2 \times S^2$  back to  $S^1 \times D^2$  (i.e. replacing the dot in Figure 3.1).

**Theorem 3.1.2.** (Akbulut-Yasui [6, Theorem 2.5(2)]) For  $m \geq 1$  and  $n \geq 2$ , the pair  $(W_{m,n}, f_{m,n})$  is a plug.

### 3.2 Proofs of Theorems 1.0.3 and 1.0.4.

We write Theorem 1.0.3 again here.

**Theorem 1.0.3.** For any  $m \geq 1, n \geq 2$ , Akbulut-Yasui plug  $(W_{m,n}, f_{m,n})$  admit genus zero PALF structure. The monodromy of the PALF is described by the factorization  $t_{\alpha_{2n+m}} \cdots t_{\alpha_1}$ , where  $t_\alpha$  is a right-handed Dehn twist along a simple closed curve  $\alpha$  on a fiber and  $\alpha_{2n+m}, \dots, \alpha_1$  are simple closed curves shown in Figure 3.2.

*Proof of Theorem 1.0.3.* Let  $F_{m,n}$  be the compact oriented surface of genus zero with  $2n + m$  boundary components and  $\alpha_1, \dots, \alpha_{2n+m}$  the curves on  $F_{m,n}$  shown in Figure 3.4 (a). Note that Figure 3.2 and Figure 3.4 (a) show the same PALF. We denote the right-handed Dehn twists along  $\alpha_1, \dots, \alpha_{2n+m}$  by

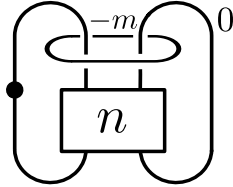
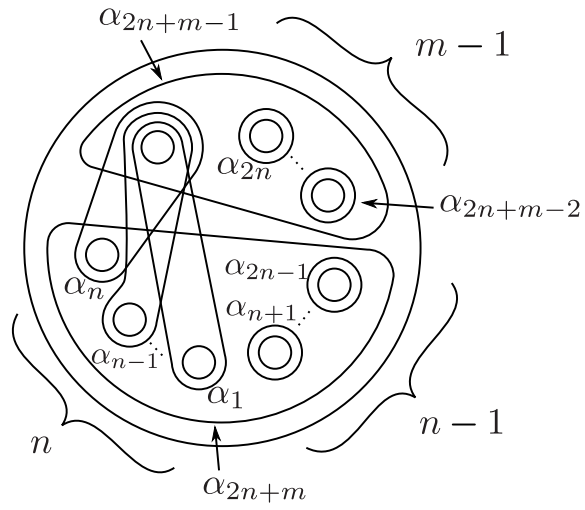
Figure 3.1: Kirby diagram for  $W_{m,n}$ Figure 3.2: Vanishing cycles of a genus zero PALF on  $W_{m,n}$ .

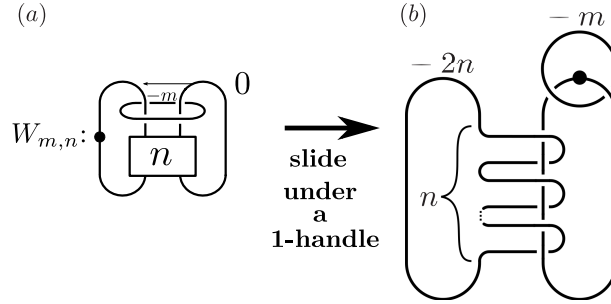

Figure 3.3:

$t_{\alpha_1}, \dots, t_{\alpha_{2n+m}}$ , respectively. Let  $f : X_{m,n} \rightarrow D^2$  be a Lefschetz fibration over  $D^2$  with monodromy representation  $(t_{\alpha_{2n+m}}, \dots, t_{\alpha_1})$ . Since each curve  $\alpha_i$  is homologically non-trivial on  $F_{m,n}$ , we see that  $f$  is a PALF with fiber  $F_{m,n}$ .

We now show that  $X_{m,n}$  is diffeomorphic to  $W_{m,n}$ .

The Kirby diagram for  $X_{m,n}$  corresponding to the monodromy representation  $(t_{\alpha_{2n+m}}, \dots, t_{\alpha_1})$  is given by Figure 3.4 (b). We slide the  $-1$ -framed 2-handles over  $-1$ -framed 2-handles and erase cancelling 1-handle/2-handle pairs to get Figure 3.4 (c). We get Figure 3.4 (d) by sliding the  $-m$ -framed 2-handle over  $-1$ -framed 2-handles and sliding the  $-n$ -framed 2-handle over  $-1$ -framed 2-handles and erasing cancelling 1-handle/2-handle pairs.

The Kirby diagram for  $W_{m,n}$  is given by Figure 3.3 (a). We slide the 0-framed 2-handle under the 1-handle to get Figure 3.3 (b).

Since Figure 3.3 (b) and Figure 3.4 (d) are the same, we conclude that  $X_{m,n}$  is diffeomorphic to  $W_{m,n}$ , which implies the theorem.  $\square$

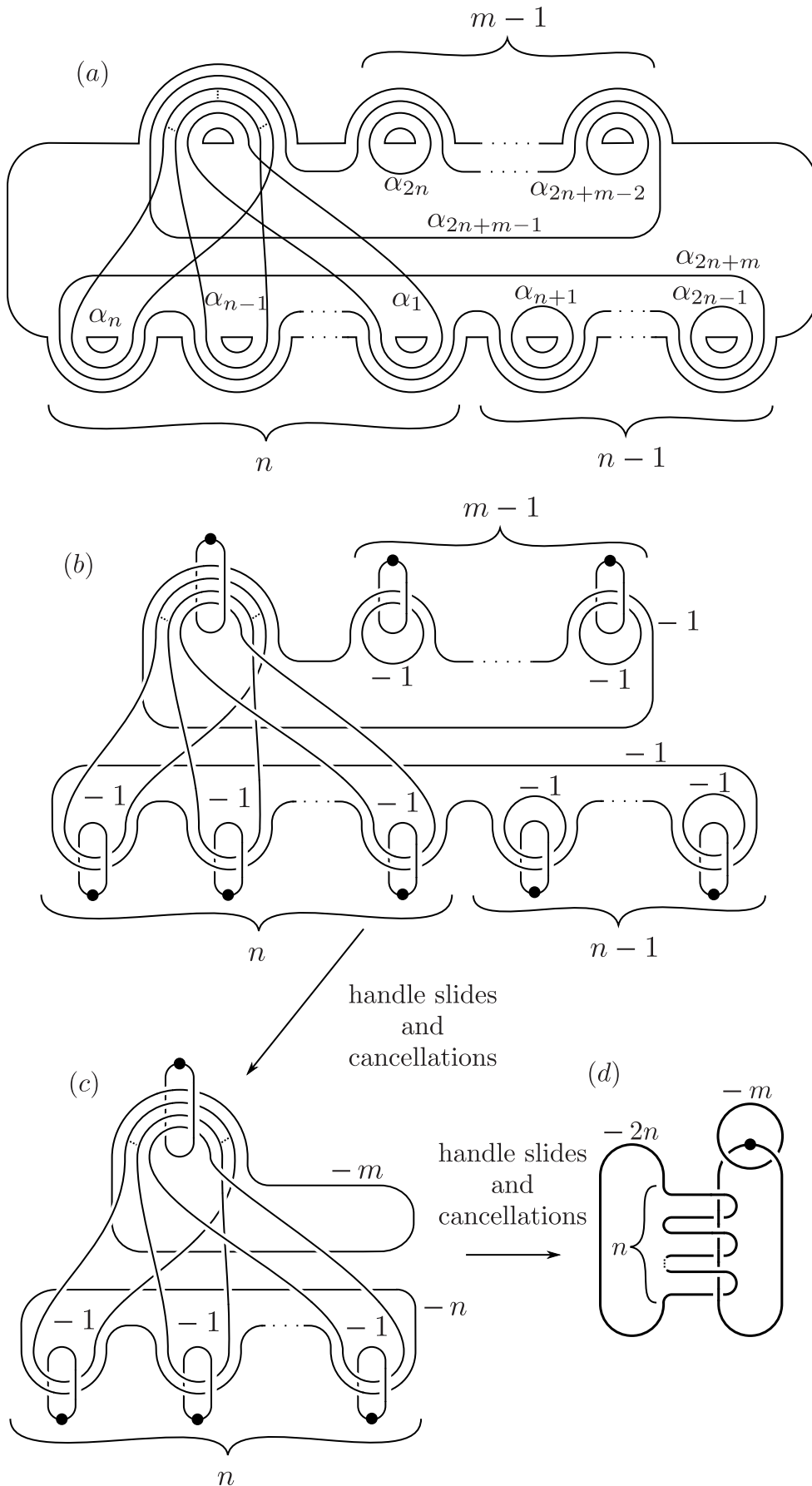

Figure 3.4:

We write Theorem 1.0.4 again here.

**Theorem 1.0.4.** *The manifolds  $A$  and  $B$  which are showed by the Kirby diagrams in the Figure 3.5 have following propaties.*

- (1)  $B$  is obtained by plug twist of  $A$  along Akbulut-Yasui plug  $(W_{1,2}, f_{1,2})$ .
- (2)  $A, B$  admit genus zero PALF structure.
- (3) Betti numbers of  $A$  and  $B$  are 2, and Homology groups of  $A$  and  $B$  are isomorphic.
- (4) The boundaries of  $A$  and  $B$  are diffeomorphic.
- (5)  $A, B$  do not have isomorphic intersection numbers. Especially  $A$  and  $B$  are not homeomorphic.
- (6) The monodromy representation of genus zero PALF structures which  $W_{1,2}$  admits is  $t_{\alpha_5}t_{\alpha_4}t_{\alpha_3}t_{\alpha_2}t_{\alpha_1}$ , where  $\alpha_i$  is a simple closed curve in diagram 3.6, and  $t_{\alpha_i}$  is right-handed Dehn twist along  $\alpha_i$ . Monodoromy representations of genus zero PALF structure of  $A, B$  are  $t_{\alpha_5}t_{\alpha_4}t_{\alpha_3}t_{\alpha_2}t_{\alpha_1}t_{\beta}$  and  $t_{\alpha_5}t_{\alpha_4}t_{\alpha_3}t_{\alpha_2}t_{\alpha_1}t_{\gamma}$ , where  $\beta, \gamma$  is simple closed curve in the diagram 3.7, 3.8.

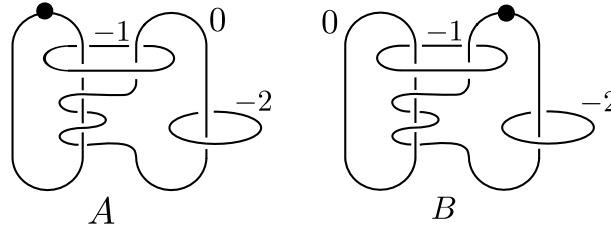

Figure 3.5: Kirby diagrams for  $A$  and  $B$ .

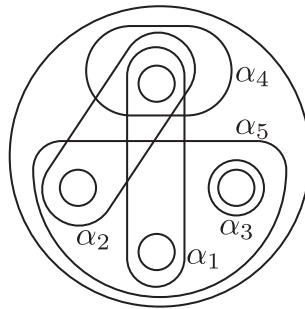

Figure 3.6: Vanishing cycles of a genus zero PALF on  $W_{1,2}$ .

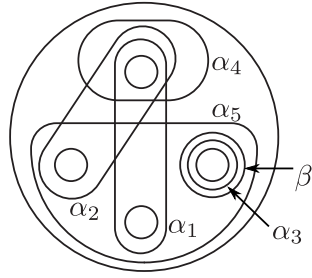

Figure 3.7: Vanishing cycles of a genus zero PALF.

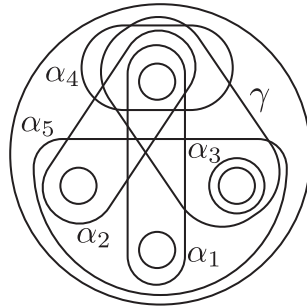

Figure 3.8: Vanishing cycles of a genus one PALF.

*Proof of Theorem 1.0.4.* (1) The plug twist of  $A$  along  $(W_{1,2}, f_{1,2})$  is represented by replacing the dot with 0 mutually by the definition of the Akbulut-Yasui plug. Therefore  $B$  is obtained from  $A$  by plug twisting along  $(W_{1,2}, f_{1,2})$ .

(2) First, we transform the Kirby diagram of  $A$  as in Figure 3.12. Figure 3.12 (a) is the Kirby diagram of  $A$ . We slide the 0-framed 2-handle under the 1-handle to get Figure 3.12 (b). We get Figure 3.12 (c) by creating cancelling 1-handle/2-handle pairs. We create cancelling pairs to get Figure 3.12 (d). Then we consider the 4-manifold with genus zero PALF structure as in Figure 3.7. The obvious Kirby diagram for this manifold is given by Figure 3.9. Therefore, the manifold  $A$  admits a genus zero PALF structure. Similarly, we transform the Kirby diagram of  $B$  as in Figure 3.13. Figure 3.13 (a) is the Kirby diagram of  $B$ . We slide the 0-framed 2-handle under the 1-handle to get Figure 3.13 (b). We get Figure 3.13 (c) by creating cancelling 1-handle/2-handle pairs. We create cancelling pairs to get Figure 3.13 (d). Then we consider a 4-manifold which admits a genus zero PALF structure as in Figure 3.8. The obvious Kirby diagram for this manifold is given by Figure 3.11. Therefore, the manifold  $A$  admits a genus zero PALF structure.

(3) We give a handle decomposition of  $A$  and  $B$  with one 0-handle, two 2-handles as in Figure 3.5. Therefore,  $H_0(A; \mathbb{Z}) \cong H_0(B; \mathbb{Z}) \cong \mathbb{Z}$ ,  $H_1(A; \mathbb{Z}) \cong H_1(B; \mathbb{Z}) \cong \{0\}$ ,  $H_2(A; \mathbb{Z}) \cong H_2(B; \mathbb{Z}) \cong \mathbb{Z} \oplus \mathbb{Z}$ , and  $H_i(A; \mathbb{Z}) \cong H_i(B; \mathbb{Z}) \cong \{0\}$  ( $i \geq 3$ ). The second Betti numbers of  $A$  and  $B$  are equal to 2.

(4) By the Kirby diagrams of  $A$  and  $B$  (Figure 3.5), both of the boundaries of  $A$  and  $B$  are represented by integral surgery diagrams. Therefore the boundaries of  $A$  and  $B$  are diffeomorphic to each other.

(5) We transform the Kirby diagrams of the manifolds  $A$  and  $B$  by Kirby calculus in Figure 3.14 and Figure 3.15. We obtain the intersection matrices

$$\begin{pmatrix} -8 & 1 \\ 1 & -2 \end{pmatrix} \text{ and } \begin{pmatrix} -8 & -3 \\ -3 & -3 \end{pmatrix}$$

of  $A$  and  $B$  from the diagrams, respectively. The former is even and the latter is odd. Therefore  $A$  and  $B$  do not have isomorphic intersection form, especially  $A$  and  $B$  are not homeomorphic.

(6) The genus zero PALF structure on  $W_{1,2}$  is obtained from a trivial surface bundle over  $D^2$  by attaching Lefschetz 2-handles along simple closed curves in Figure 3.6. The genus zero PALF structure  $A$  (respectively  $B$ ) is obtained from surface bundle over  $D^2$  by attaching Lefschetz 2-handles along simple closed curves in Figure 3.7 (respectively Figure 3.8). Therefore the monodromy representation of the PALF on  $A$  (respectively  $B$ ) is  $t_{\alpha_5} t_{\alpha_4} t_{\alpha_3} t_{\alpha_2} t_{\alpha_1} t_{\beta}$  (respectively  $t_{\alpha_5} t_{\alpha_4} t_{\alpha_3} t_{\alpha_2} t_{\alpha_1} t_{\gamma}$ ) (where  $t_{\alpha_i}$  is right-handed Dehn twist along the simple closed curve  $\alpha_i$ ).  $\square$

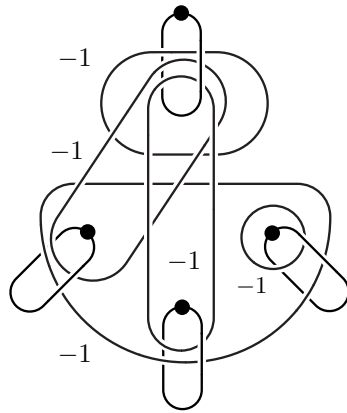

Figure 3.9:

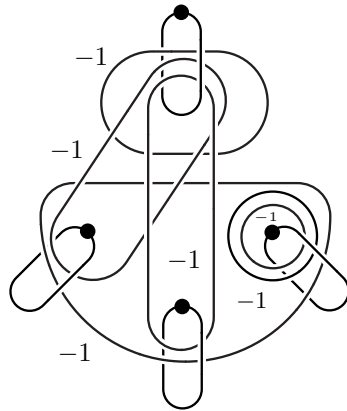

Figure 3.10:

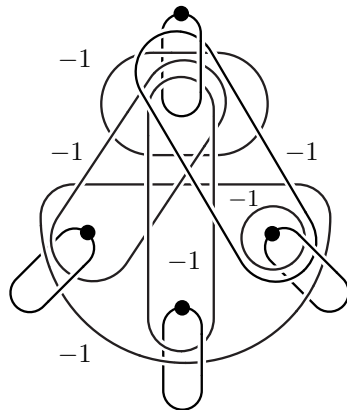

Figure 3.11:

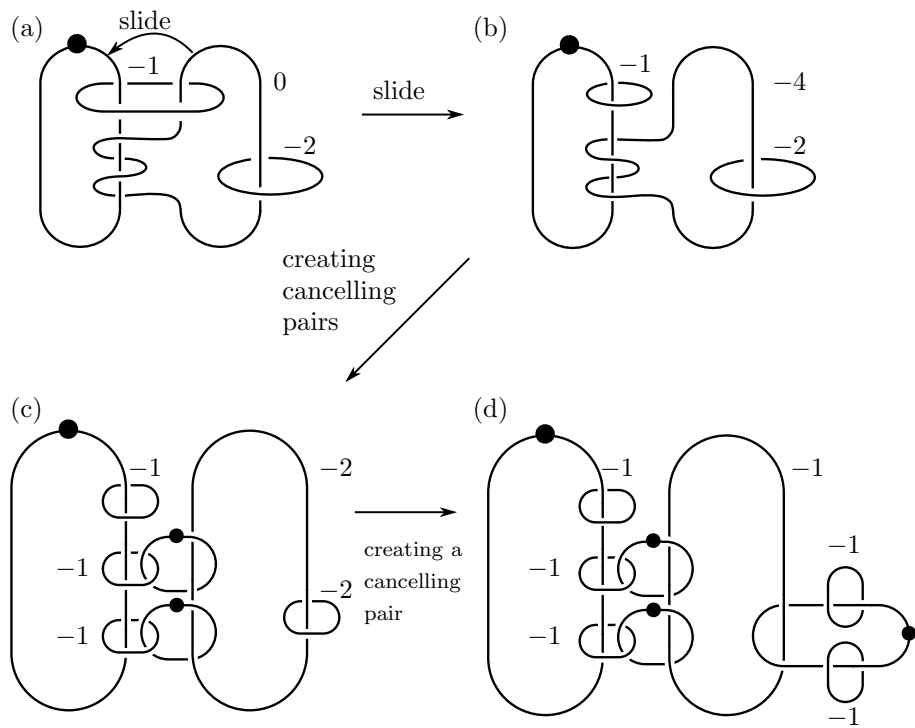

Figure 3.12:

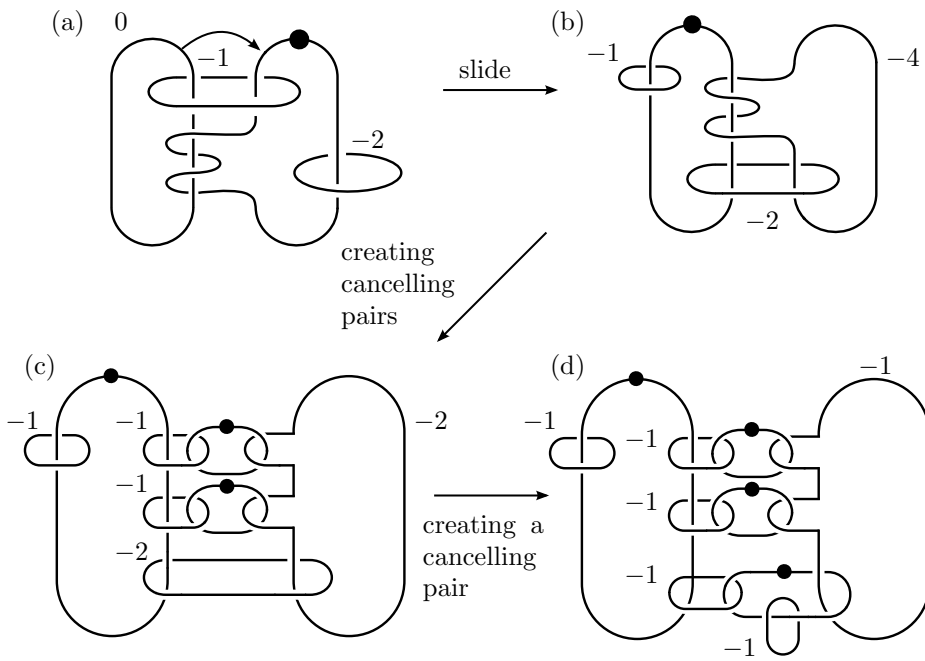

Figure 3.13:

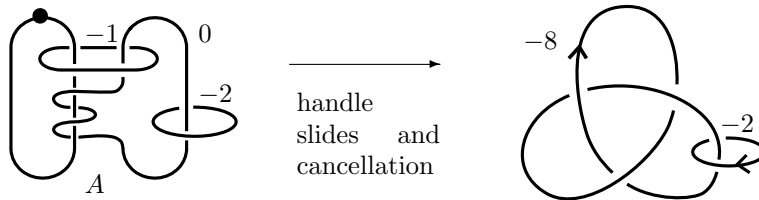

Figure 3.14:

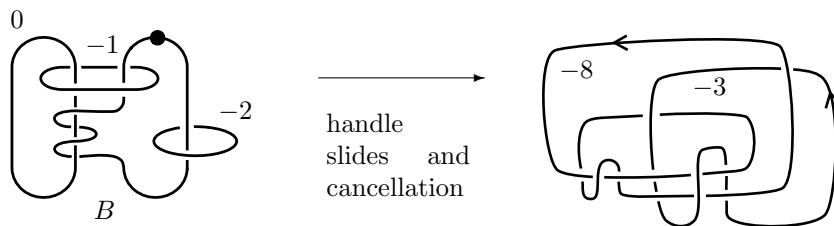

Figure 3.15:

## Chapter 4

# Genus zero PALF and Stein structures with distinct Ozsváth-Szabó invariants on cork

### 4.1 Proof of Theorem 1.0.6

The results in Chapter 4 of the thesis are based on joint work with Çağrı Karakurt and Takahiro Oba [13].

We write Theorem 1.0.6 once again here.

**Theorem 1.0.6.** *There exists an infinite family  $\{W^n : n \in \mathbb{N}\}$  of compact contractible 4-manifolds with boundary and Stein structures  $J_1^n$  and  $J_2^n$  on  $W^n$  satisfying the following properties:*

1. *The  $\text{Spin}^c$  structures  $\mathfrak{s}_1^n$  and  $\mathfrak{s}_2^n$  associated to  $J_1^n$  and  $J_2^n$ , respectively, are the same for every  $n \in \mathbb{N}$ .*
2. *The induced contact structures  $\xi_1^n$  and  $\xi_2^n$  on  $\partial W^n$  have distinct Ozsváth-Szabó invariants, in fact  $\pi(c^+(\xi_1^n)) \neq 0$  and  $\pi(c^+(\xi_2^n)) = 0$ , for every  $n \in \mathbb{N}$ .*
3. *the Casson invariant of  $\partial W^n$  is given by  $\lambda(\partial W^n) = 2n$  for every  $n \in \mathbb{N}$ .*
4.  *$\partial W^n$  is irreducible for every  $n \in \mathbb{N}$ .*

First recall the terminology from [4]. Let  $L$  be a link in  $S^3$  with two components  $K_1 \cup K_2$ . We say that  $L$  is an *admissible* link if it satisfies the following conditions:

1. Both  $K_1$  and  $K_2$  are unknotted.

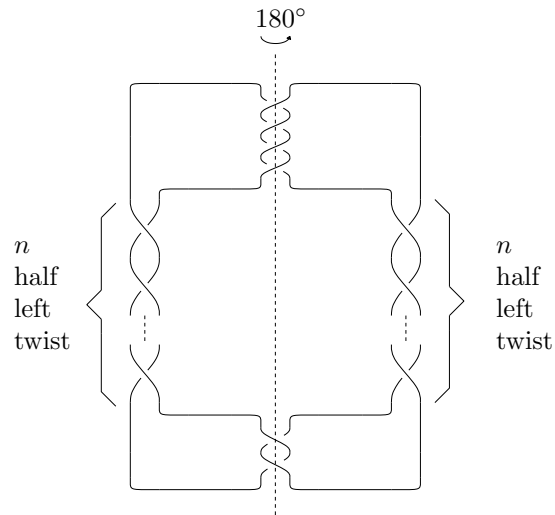

Figure 4.1: Symmetric picture of  $L^n$ . The indicated involution exchanges the components.

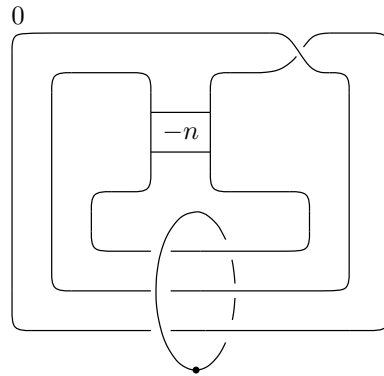

Figure 4.2: The handlebody  $W^n = W(L^n)$ . The box indicates  $n$  full left twists.

2. An involution of  $S^3$  exchanges  $K_1$  and  $K_2$ .
3. The linking number of  $K_1$  and  $K_2$  is  $\pm 1$ .
4. Carve out a disk bounded by  $K_1$  and regard  $K_2 \subset S^1 \times S^2 = \partial(S^1 \times B^3)$  equipped with the unique Stein fillable contact structure. Then the maximal Thurston-Bennequin number of  $K_2$  is at least  $+1$ .

From an admissible link, we can construct an obvious contractible Stein handlebody  $W(L)$  by putting a dot on  $K_1$ , and attaching a 2-handle along some Legendrian representative  $K_2$  with framing one less than the Thurston-Bennequin framing (this is possible thanks to the last condition).

As in the introduction, let  $L^n$  be the link given in Figure 4.1, and let  $W^n := W(L^n)$  denote the corresponding handlebody obtained by putting a dot on one of the components and 0 on the other one as in Figure 4.2.

**Proposition 4.1.1.** *For every  $n \in \mathbb{N}$ , the link  $L^n$  is admissible.*

*Proof.* In Figure 4.1 the  $180^\circ$  rotation about the dashed axis exchanges the components of  $L^n$ . It is also clear from the figure that both components of  $L^n$  are unknotted and the linking number of these components is  $\pm 1$ . We must check that the handlebody  $W^n$  is Stein. By Eliashberg's characterization, it suffices to show that the attaching circle of the 2-handle has maximal Thurston-Bennequin number  $TB \geq 1$  in  $S^1 \times S^2$ . In Figure 4.3, we draw a Legendrian representative of the attaching circle of the 2-handle on  $S^1 \times S^2$ . From the figure we see that the writhe is  $2n + 1$  and half the number of cusps is  $2n - 1$ , implying that  $TB \geq 2$ . Hence a stabilization of the figure gives a Stein handlebody picture of  $W^n$ .

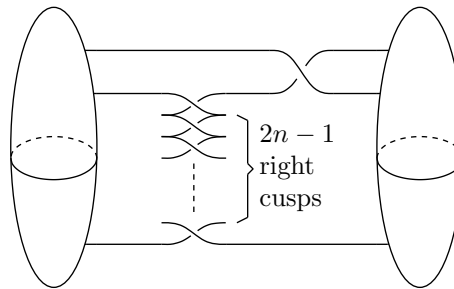

Figure 4.3: Cork  $W^n$  as a Stein handlebody (Need to stabilize the 2-handle once).

□

Denote the corresponding Stein structure on  $W^n$  (for any choice of stabilization) by  $J_1^n$ , and the induced contact structure on  $\partial W^n$  by  $\xi_1^n$ . The following result shows that  $\pi(c^+(\xi_1^n)) \neq 0$ .

**Theorem 4.1.2.** [4, Theorem 4.1] *Let  $L$  be an admissible link,  $W(L)$  be the corresponding Stein handlebody and  $\xi$  the induced contact structure on  $\partial W(L)$ . Then  $\pi(c^+(\xi)) \neq 0$ .*

It is important for the above theorem that the Stein structure is the one coming from the handlebody picture associated to an admissible link.

**Proposition 4.1.3.** *The manifold  $W^n$  admits a planar PALF for every  $n \in \mathbb{N}$ .*

*Proof.* For  $n = 1$ , this result was proved by author in [20]. We generalize author's argument in an obvious manner. We apply the handlebody moves indicated in Figure 4.4. Clearly the last diagram gives the total space of PALF whose fibers are disks with  $n + 3$  holes and monodromy is the following product of right handed Dehn twists  $t_a t_b t_c t_{d_1} \cdots t_{d_n}$  where  $a, b, c, d_1 \dots d_n$  are the curves indicated in Figure 4.5.  $\square$

Now that we know  $W^n$  admits a planar PALF, by results of Loi-Piergallini [15] and Akbulut-Ozbagci [5] there is a corresponding Stein structure on  $W^n$  which we denote by  $J_2^n$ . Let  $\xi_2^n$  be the induced contact structure on  $\partial W^n$ . Note that  $\xi_2^n$  is supported by a planar open book. The next result which is due to Ozsváth-Stipsicz-Szabó implies that  $\pi(c^+(\xi_2^n)) = 0$

**Theorem 4.1.4.** [18, Theorem 1.2] *Let  $Y$  be a 3-manifold and  $\xi$  a contact structure on  $Y$ . Suppose that  $\xi$  is supported by a planar open book decomposition. Then  $\pi(c^+(\xi)) = 0$ .*

We have just observed that the Ozsváth-Szabó invariants of  $\xi_1^n$  and  $\xi_2^n$  satisfy the required properties. It is clear that the induced  $\text{Spin}^c$  structures  $\mathfrak{s}_1^n$  and  $\mathfrak{s}_2^n$  are the same since  $W^n$  is contractible. To prove the rest of the theorem first we observe that the boundary of each  $W^n$  is the manifold  $S_{1/n}^3(K)$  which is obtained from  $S^3$  by  $1/n$ -surgery on the knot  $K$  on the left hand side of Figure 4.6.

**Lemma 4.1.5.** *We have  $\partial W^n = S_{1/n}^3(K)$  for all  $n \in \mathbb{N}$ .*

*Proof.* This was proved for  $n = 1$  by Akbulut and Kirby [3, Proposition 1-(3)]. One can easily modify their argument to see the proof in the general case. Alternatively we can apply the handlebody moves depicted in Figure 4.7 and Figure 4.8 to show that  $\partial W^n$  is obtained from  $S^3$  by  $1/n$ -surgery on a knot. It is easy to see that the knots in Figure 4.6 and at the end of Figure 4.8 are isotopic.  $\square$

Now the irreducibility of  $\partial W^n$  follows from a result of Gordon and Luecke [11] which says that if a reducible manifold appears as a surgery on a knot in  $S^3$  then one of its summands must be a lens space. Since  $\partial W^n$  is an integral homology sphere, it cannot have any non-trivial lens space summands.

**Lemma 4.1.6.** *The Alexander polynomial of the knot  $K$  is given by  $\Delta_K(t) = 2t^2 - 5t + 2$ .*

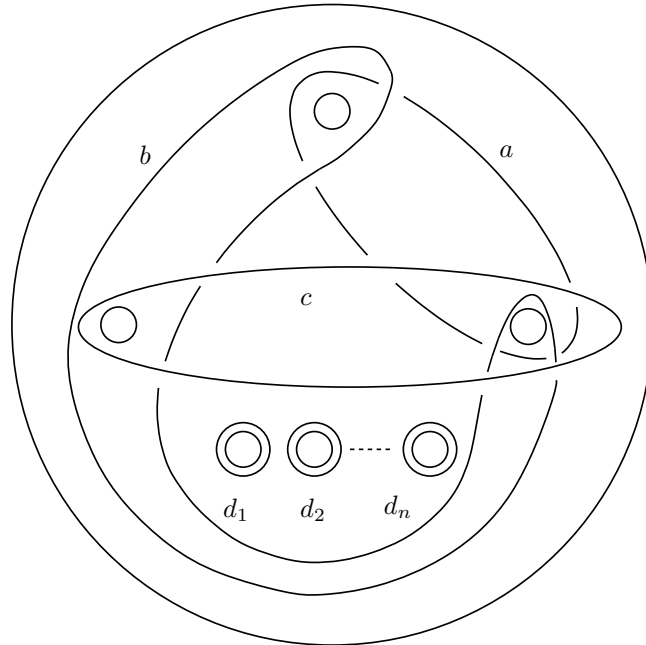
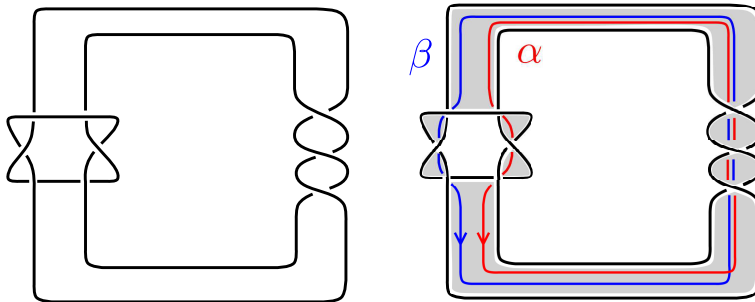

Figure 4.5: Our planar PALF on  $W^n$ Figure 4.6: The knot  $K$  is on the left. The Seifert surface of  $K$  together with its homology generators are on the right.

*Proof.* We use the Seifert surface of  $K$  that is indicated on the right hand side of Figure 4.6. With respect to the homology generators  $\alpha, \beta$ , the Seifert matrix is given by

$$S = \begin{bmatrix} 3 & -1 \\ -2 & 0 \end{bmatrix}.$$

Then the Alexander polynomial is  $\Delta_K(t) = \text{Det}(S - tS^T) = 2t^2 - 5t + 2$ .  $\square$

From the above Lemma we conclude that the Casson invariant of  $\partial W^n$  is given by

$$\lambda(\partial W^n) = \frac{n}{2} \Delta_K''(1) = 2n,$$

which finishes the proof of Theorem 1.0.6.

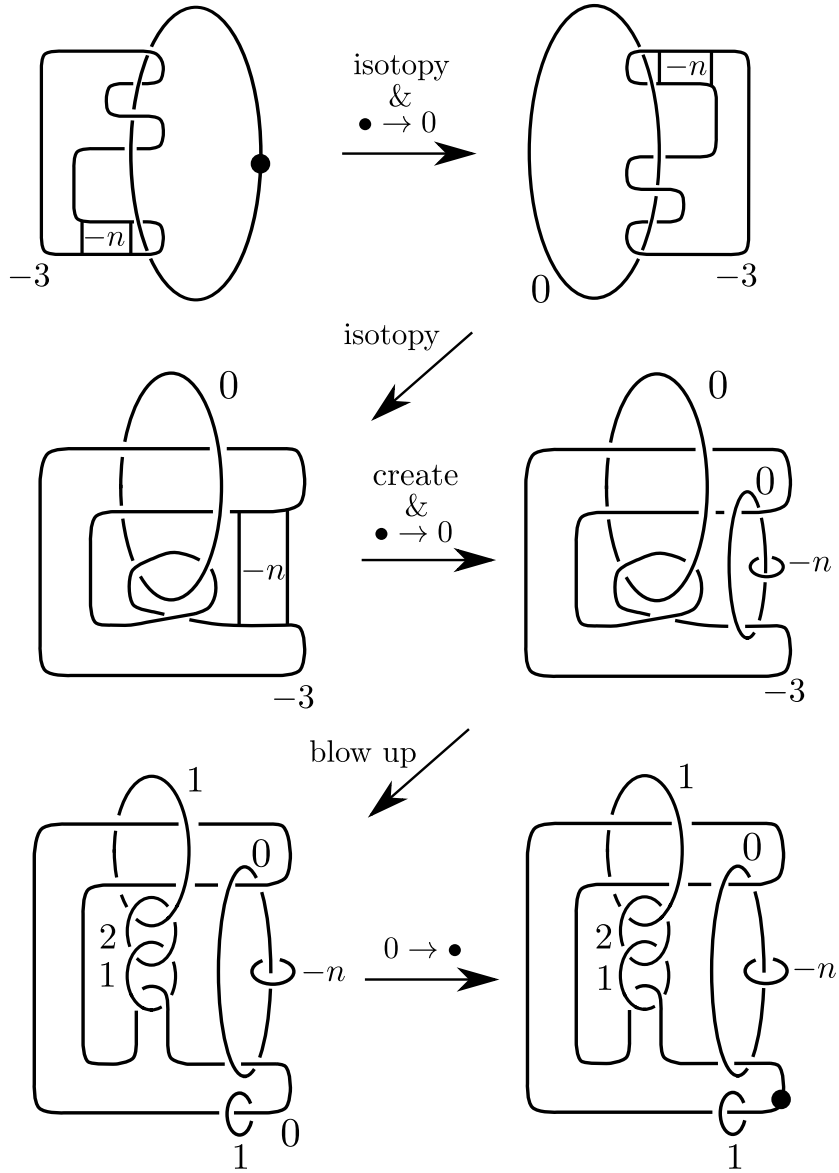

Figure 4.7:

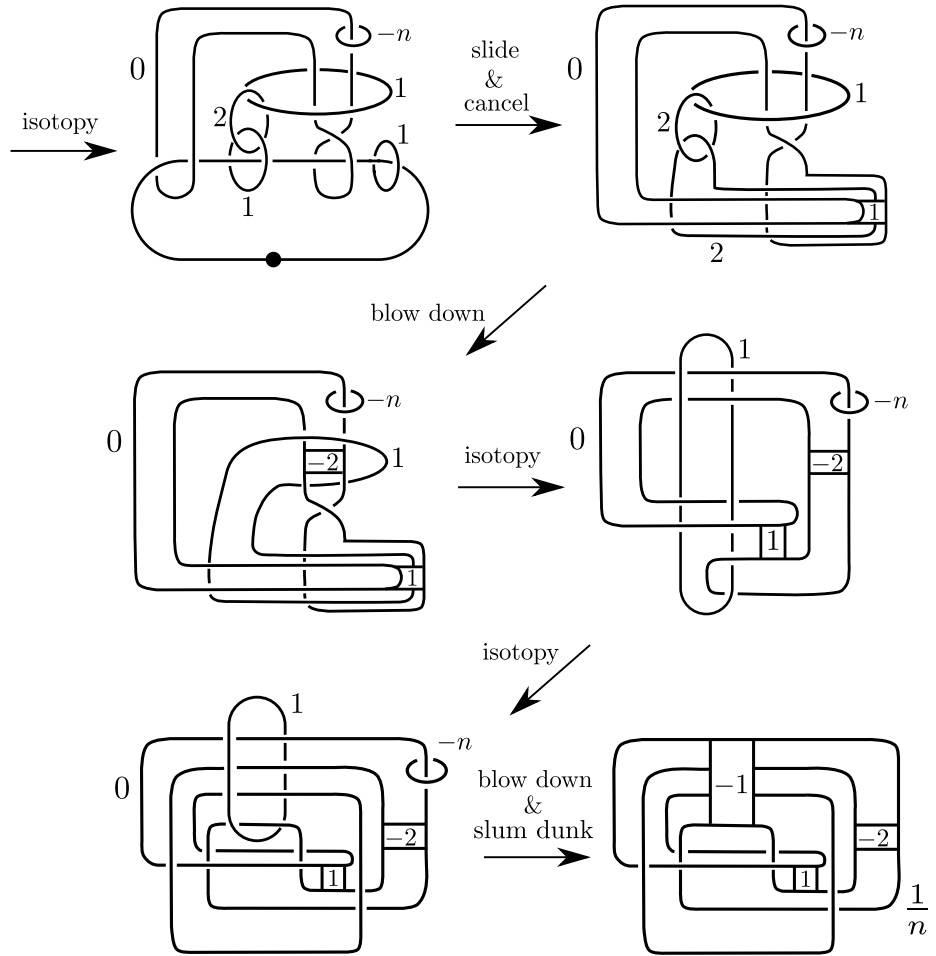

Figure 4.8:

# Bibliography

- [1] S. Akbulut, *A fake compact contractible 4-manifold*, J. Differential Geom. **33**, 335–356 (1991).
- [2] S. Akbulut and M. F. Arikan, *A note on Lefschetz fibrations on compact Stein 4-manifolds*, Commun. Contemp. Math. **14**, 1250035, 14pp (2012).
- [3] S. Akbulut and R. Kirby, *Mazur manifolds*, Michigan Math. J. **26** (1979), no. 3, 259–284. MR 544597
- [4] S. Akbulut and C. Karakurt, *Action of the cork twist on Floer homology*, Proceedings of the Gökova Geometry-Topology Conference 2011, Int. Press, Somerville, MA, 2012, pp. 42–52. MR 3076042
- [5] S. Akbulut and B. Ozbagci, *Lefschetz fibration on compact Stein surfaces*, Geom. Topol. **5**, 319–334(electronic) (2001).
- [6] S. Akbulut and K. Yasui, *Corks, Plugs and exotic structures*, Journal of Gökova Geometry Topology, **2**, 40–82 (2008).
- [7] S. Akbulut and K. Yasui, *Small exotic Stein manifolds*, Comment. Math. Helv. **85**, 705–721 (2010).
- [8] J. Cerf, *La stratification naturelle des espaces fonctions différentiables réelles et la théorème de la pseudo-isotopie*, Publ. Math. I.H.E.S. **39** (1970).
- [9] R. Gompf, *Handlebody construction of Stein surfaces*, Ann. of Math. **142**, 619–693 (1998).
- [10] R.E. Gompf and A. I. Stipsicz, *4-manifolds and Kirby calculus*, Graduate Studies in Math. **20**, A.M.S. (1999)
- [11] C. Gordon and J. Luecke, *Knots are determined by their complements*, J. Amer. Math. Soc. **2** (1989), no. 2, 371–415. MR 965210
- [12] C. Karakurt, *Contact structures on plumbed 3-manifolds*, Kyoto J. Math. **54** (2014), no. 2, 271–294. MR 3215568
- [13] C. Karakurt, T. Oba, and T. Ukida, *Planar Lefschetz fibrations and Stein structures with distinct Ozsváth-Szabó invariants on corks*, preprint 2016, arXiv:1607.07661.

- 
- [14] P. Lisca and G. Matić, *Tight contact structures and Seiberg-Witten invariants*, *Invent. Math.* **129** (1997), no. 3, 509–525. MR 1465333
- [15] A. Loi and R. Piergallini, *Compact Stein surfaces with boundary as branched covers of  $B^4$* , *Invent. Math.* **143**, 325–348 (2001).
- [16] T. Oba, *A note on Mazur type Stein fillings of planar contact manifolds*, *Topology Appl.* **193** (2015), 302–308. MR 3385100
- [17] B. Ozbagci and A. I. Stipsicz, *Surgery on contact 3-manifolds and Stein surfaces*, *Bolyai Society Mathematical Studies*, **13**(2004), Springer-Verlag, Berlin; János Bolyai Mathematical Society, Budapest, 2004.
- [18] P. Ozsváth, A. Stipsicz, and Z. Szabó, *Planar open books and Floer homology*, *Int. Math. Res. Not.* (2005), no. 54, 3385–3401. MR 2200085 (2006j:57056)
- [19] O. Plamenevskaya, *Contact structures with distinct Heegaard Floer invariants*, *Math. Res. Lett.* **11** (2004), no. 4, 547–561. MR 2092907
- [20] T. Ukida, *A genus zero Lefschetz fibration on the Akbulut cork*, *Topology and its Applications* **214** (2016), 127–136.